

293/630 EM

Dimensions

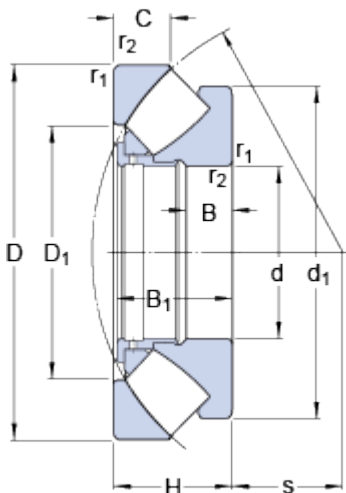

d	630	mm
D	950	mm
H	190	mm
d ₁	≈ 880	mm
D ₁	≈ 761	mm
B	68	mm
B ₁	183	mm
C	92	mm
s	359	mm
r _{1,2}	min. 9.5	mm

Abutment dimensions

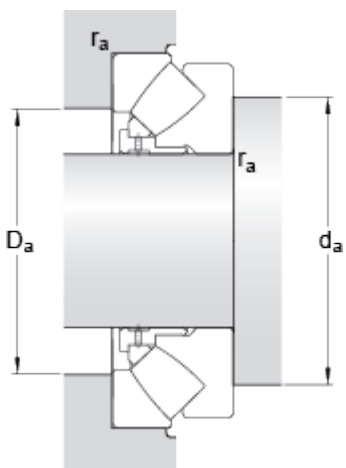

d _a	min. 795	mm
D _a	max. 860	mm
r _a	max. 8	mm

Calculation data

Basic dynamic load rating	C	8450	kN
Basic static load rating	C ₀	38000	kN
Fatigue load limit	P _u	2900	kN
Reference speed		320	r/min
Limiting speed		600	r/min
Minimum axial load factor	A	140	

Mass

Mass bearing		485	kg
--------------	--	-----	----